

HKC Technology Limited
2.4GHz Multi-line and Multi-handset
Cordless Telephone System

Quick Guide
Desktop Extension
(WDE ER)

Please read the User Guide for complete instruction.

- Keep this leaflet for future reference

Check the accessories:

- | | | | |
|---|-----|-------------------------------------|-----|
| <input type="checkbox"/> Handset | one | <input type="checkbox"/> AC Adaptor | one |
| <input type="checkbox"/> Handset Cord | one | <input type="checkbox"/> Battery | one |
| <input type="checkbox"/> Stand / Wall Mount | one | | |

Installation:

1. Connecting the handset

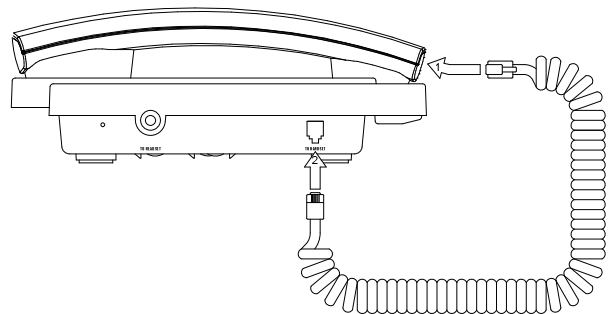

2. Connecting the battery

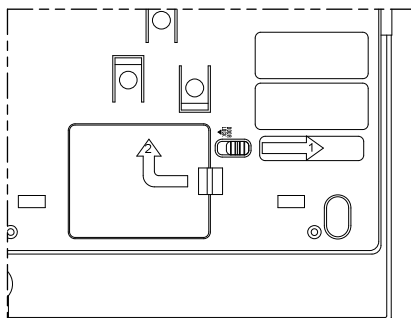

a. Open the battery door cover

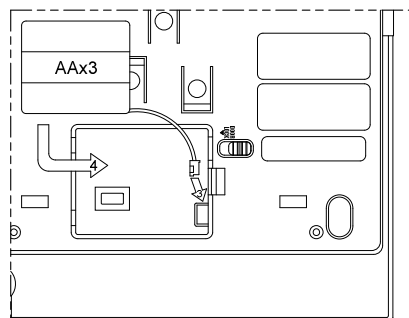

b. Install the battery

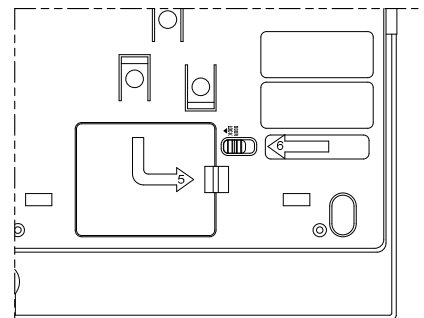

c. Close the battery door

3. Connecting the AC adaptor

The extension is also powered by an AC power when the AC adaptor is connected to an AC outlet (AC power mode). At the same time, the battery is being charged

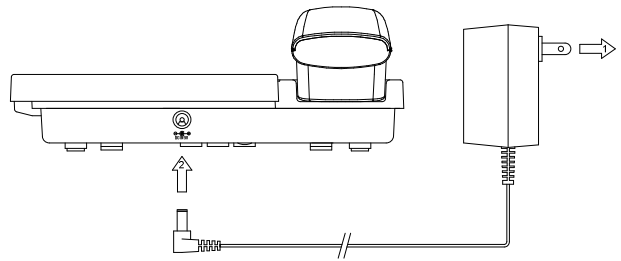

4. Charging the Battery

Before initial use, the battery should be charged for about 8 hours. When possible, keep the extension in the AC power mode to provided optimum battery performance.

5. System Connection

Before using the Cordless Desktop Extension (WDE ER) to make a call, the extension must be registered to a wireless telephone Main Control Base (WMC ER).

A maximum of 10 Extensions in any combination of WDE ER and the cordless handheld extensions (WHE ER) can be registered to a WMC ER.

Registration:

For convenience, the desktop extension is set as extension 0 and the other two handheld extensions are set as extension 1 & 2 respectively in the complete system package. When additional extensions are required, you can register them as below from extension 3 to 9 without duplication.

Make sure that the main control base and the extension are in the standby mode. Registration must be completed within one minute.

When the extension is not registered to the Main Control Base, it shows 'Unregister.Handset' You have to register all extensions to the Main Control Base.



1. Press the **MENU** key of your extension, scroll the **▲** up or **▼** down key to select "register" and press the soft key **SELECTION** to confirm.



2. Select "register" from the sub menu by using the scroll key and press soft key **OK** to confirm.



3. Press the soft key **OK** to confirm "REALLY REGISTER?"

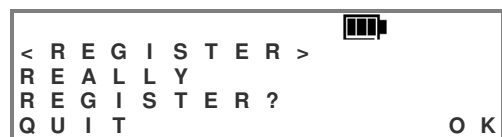

4. Input EXT NO 0-9 (example: say '0', press the dial key '0' and then press soft key **OK** to confirm.



5. After assigning the extension number, press the "SET" button on the Main Control Unit and wait for a beep sound.



6. Press the soft key **OK** to confirm the registration on the extension. Only one unit can be registered at a time using the main control base.



If you press "Quit" during registration, the extension will fail to register.

7. Set User name: Continue to enter a name by pressing the dial keypad and press the soft key **OK** when finish.



Using the phone:

Outgoing Call

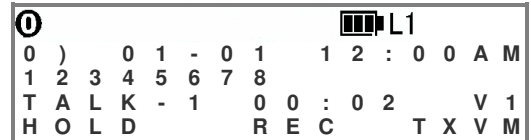

Handset Mode: Pick up the handset and get an available line, L1-L3 automatically. Or, you may press the line key directly when the Line is idle. Press the phone number.

Hands Free Mode: Press the speaker key and get an available line, L1-L3 automatically. Or you may press the line key directly when the Line is idle. Press the phone number

Intercom Call

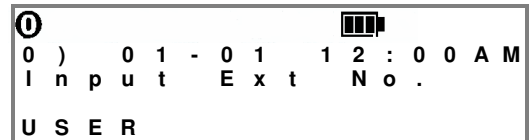

Handset Mode: Pick up the handset and press the **INTERCOM** key. You can hear an internal dial tone. Press the extension number.

Hands Free Mode: Press the **INTERCOM** key and press the extension number.

Receiving Incoming Call

Handset Mode: Pick up the handset when the phone is ringing.

Hands Free Mode: Press the speaker key when the phone is ringing.

Receiving Intercom Call

Handset Mode: Pick up the handset when the phone is ringing.

Hands Free Mode: Press speaker key when the phone is ringing.

Redial

The phone stores the number of the last outgoing call. You can press **Redial** key and then press **Speaker** or pick up the handset to select an available line to make an outgoing call by using the stored number.